

4.7

Surface Area of a Right Cylinder

Focus Find the surface area of a right cylinder.

What is the area of this circle?

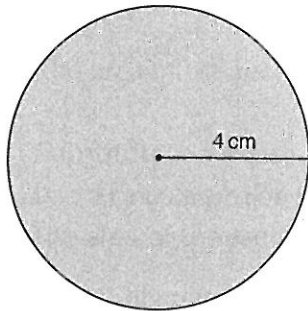

What is the circumference of this circle?

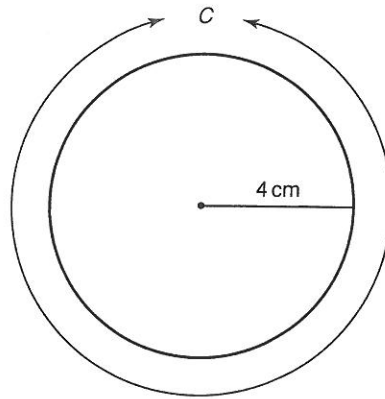

Investigate

Work with a partner.

You will need a cardboard tube, scissors, and tape.
Cut out two circles to fit the ends of the tube.
Hold a circle at each end of the tube.
You now have a right cylinder.

Find a way to calculate the surface area of the cylinder.

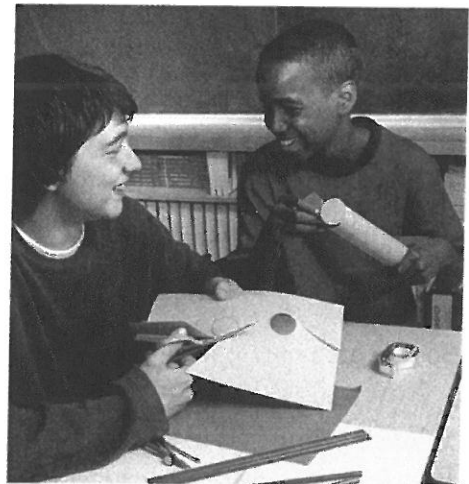

Reflect & Share

Share your strategy for finding the surface area with another pair of classmates.

Did you use the same strategy?

If not, do both strategies work?

How could you check?

Connect

The bases of a right cylinder are 2 congruent circles.
 The curved surface of a cylinder is a rectangle when laid flat.
 These 3 shapes make the net of a cylinder.

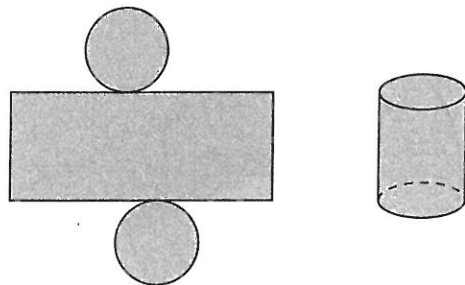

The surface area of a cylinder = $2 \times$ area of one circular base + area of a rectangle
 Label the cylinder and its net.

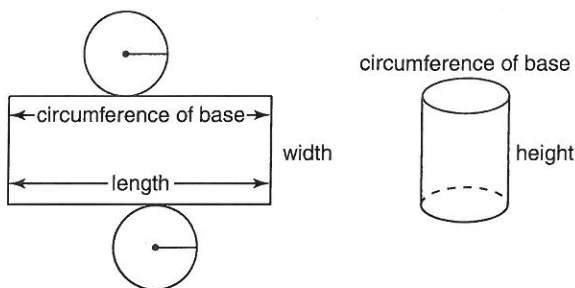

The width of the rectangle is equal to the height of the cylinder.
 The length of the rectangle is equal to the circumference of the base of the cylinder.

So, the area of the rectangle = circumference of base \times height of cylinder

When a cylinder is like a cardboard tube and has no circular bases, its surface area is the curved surface only:

Curved surface area = circumference of base \times height of cylinder

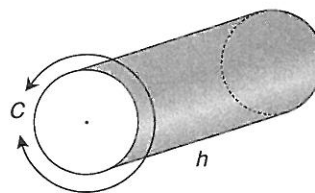

Example 1

Find the surface area of this cylinder.

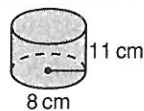

A Solution

Sketch the net.

Surface area = $2 \times$ area of one circle + area of the rectangle

- The area of the circle is: $A = \pi r^2$

Substitute: $r = 8$

$$\begin{aligned}\text{So, area of circle is: } A &= \pi \times 8^2 \\ &\doteq 201.06\end{aligned}$$

- The area of the rectangle = circumference \times height
 $= 2\pi r \times h$

Substitute: $r = 8$ and $h = 11$

Use a calculator. For π , press the π key.

$$\begin{aligned}\text{The area of the rectangle} &= 2\pi \times 8 \times 11 \\ &\doteq 552.92\end{aligned}$$

$$\begin{aligned}\text{Surface area} &\doteq 2 \times 201.06 + 552.92 \\ &= 955.04\end{aligned}$$

The surface area of the cylinder is about 955 cm^2 .

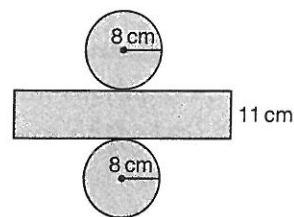

Example 2

A manufacturer produces a can with height 7 cm and diameter 5 cm.

What is the surface area of the label, to one decimal place?

A Solution

Sketch the can.

The label does not cover the circular bases.

So, the surface area of the label is equal to the curved surface area of the can.

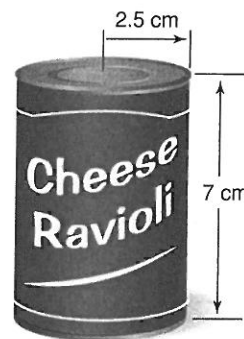

$$\begin{aligned}\text{Curved surface area} &= \text{circumference of base} \times \text{height of cylinder} \\ &= \pi d \times h\end{aligned}$$

Substitute: $d = 5$ and $h = 7$

Use a calculator. For π , press the π key.

$$\begin{aligned}\text{Curved surface area} &= \pi \times 5 \times 7 \\ &\doteq 109.956\end{aligned}$$

The surface area of the label is 110.0 cm^2 , to one decimal place.

Discuss the ideas

- In *Example 2*, what is the surface area of the can?
The can is opened and one end removed.
What is the surface area of the open can?
- What is an algebraic formula for the surface area of a right cylinder with height h and radius r ?
- Why is the surface area of a cylinder always approximate?

Practice

Check

Give each area to the nearest square unit.

4. Find the area of each net.

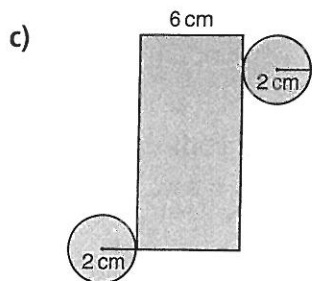
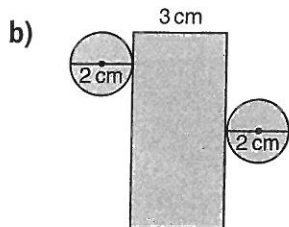
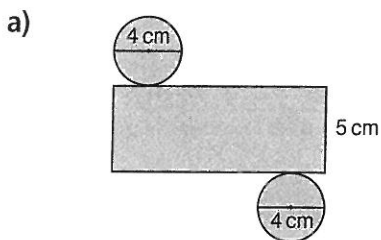

5. Describe the cylinder that each net in question 4 forms.

6. Calculate the curved surface area of each tube.

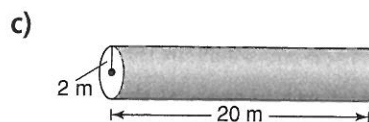
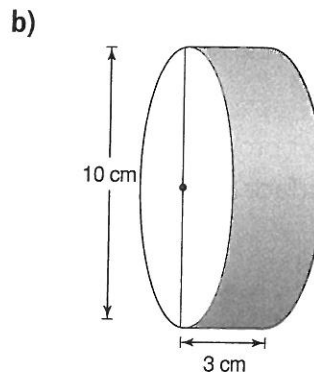
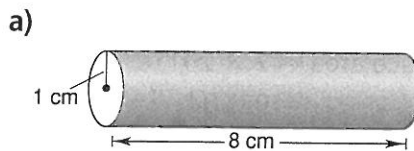

7. Find a right cylinder in the classroom. Use thin string to find its circumference. Use a ruler to measure its radius and height. Calculate the surface area of the cylinder.

Apply

8. Calculate the surface area of each cylinder.

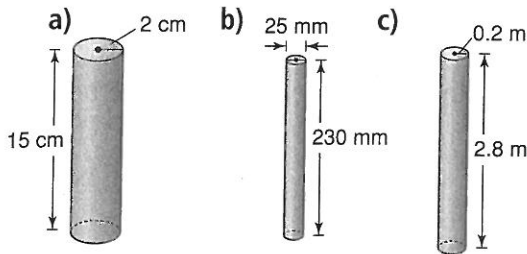

9. A cylindrical tank has diameter 3.8 m and length 12.7 m. What is the surface area of the tank?
10. Cylindrical paper dryers are used in pulp and paper mills. One dryer has diameter 1.5 m and length 2.5 m. What is the area of the curved surface of this dryer?
11. A wooden toy kit has different painted solids. One solid is a cylinder with diameter 2 cm and height 14 cm.

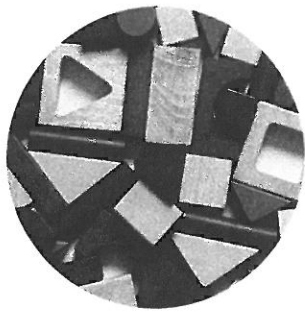

- a) What is the surface area of the cylinder?
- b) One can of paint covers 40 m^2 . Each cylinder is painted with one coat of paint. How many cylinders can be painted with one can of paint?

12. Assessment Focus

A soup can has diameter 6.6 cm. The label on the can is 8.8 cm high. There is a 1-cm overlap on the label. What is the area of the label?

13. A hot water tank is cylindrical. Its interior is insulated to reduce heat loss. The interior has height 1.5 m and diameter 65 cm. What is the surface area of the interior of the tank? Give the answer in two different square units.
14. A tom-tom hoop drum is made of stretched membranes, called heads, which are held tightly across a tubular shell. The drum has diameter 30 cm and height 30 cm. The shell of the drum is made of 5 layers of birch sheathing.

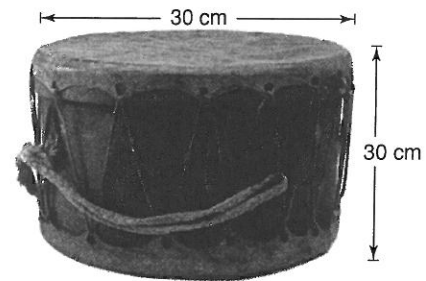

- a) How much sheathing is needed to make the shell?
- b) Suppose the drum has two heads. How much membrane would you need to make the heads? What assumptions do you make?

15. A candy company can sell fruit gums in rectangular boxes or in cylindrical tubes. Each box is 8 cm by 3 cm by 7 cm. Each cylinder has radius 3 cm and height 6 cm. The company wants the packaging that uses less material. Which packaging should the company choose? Justify your choice.

16. Take It Further

The curved surface area of a solid cylinder is 660 cm^2 .

The cylinder has height 10 cm.

- What is the circumference of the cylinder?
- What is the radius of the cylinder?
- What is the area of one circular base?
- What is the surface area of the cylinder?

17. Take It Further Benny places a glass cylinder, open at one end, over a rose cutting in his garden. The cylinder has diameter 9 cm and height 20 cm. To make sure animals cannot knock the cylinder over, Benny covers the bottom 5 cm of the cylinder with soil. What is the surface area of the cylinder exposed to the sun?



Math Link

History

In the late 1800s, Thomas Edison developed the earliest method for recording sound, the phonograph cylinder. The open cylinder was made of wax. Audio recordings were etched on its outside surface. The sounds were reproduced when the cylinder was played on a mechanical phonograph. There are about 3312 original wax cylinders recorded by First Nations and French Canadian people on display at the Canadian Museum of Civilization in Gatineau, Quebec.

The standard wax cylinder had diameter about 5.5 cm and height 10.5 cm. What surface area was available to be etched?



Reflect

How is the formula for the surface area of a cylinder related to the net of the cylinder? Include a diagram in your explanation.